

Схема подключений, инкубационный шкаф.
Выводная камера

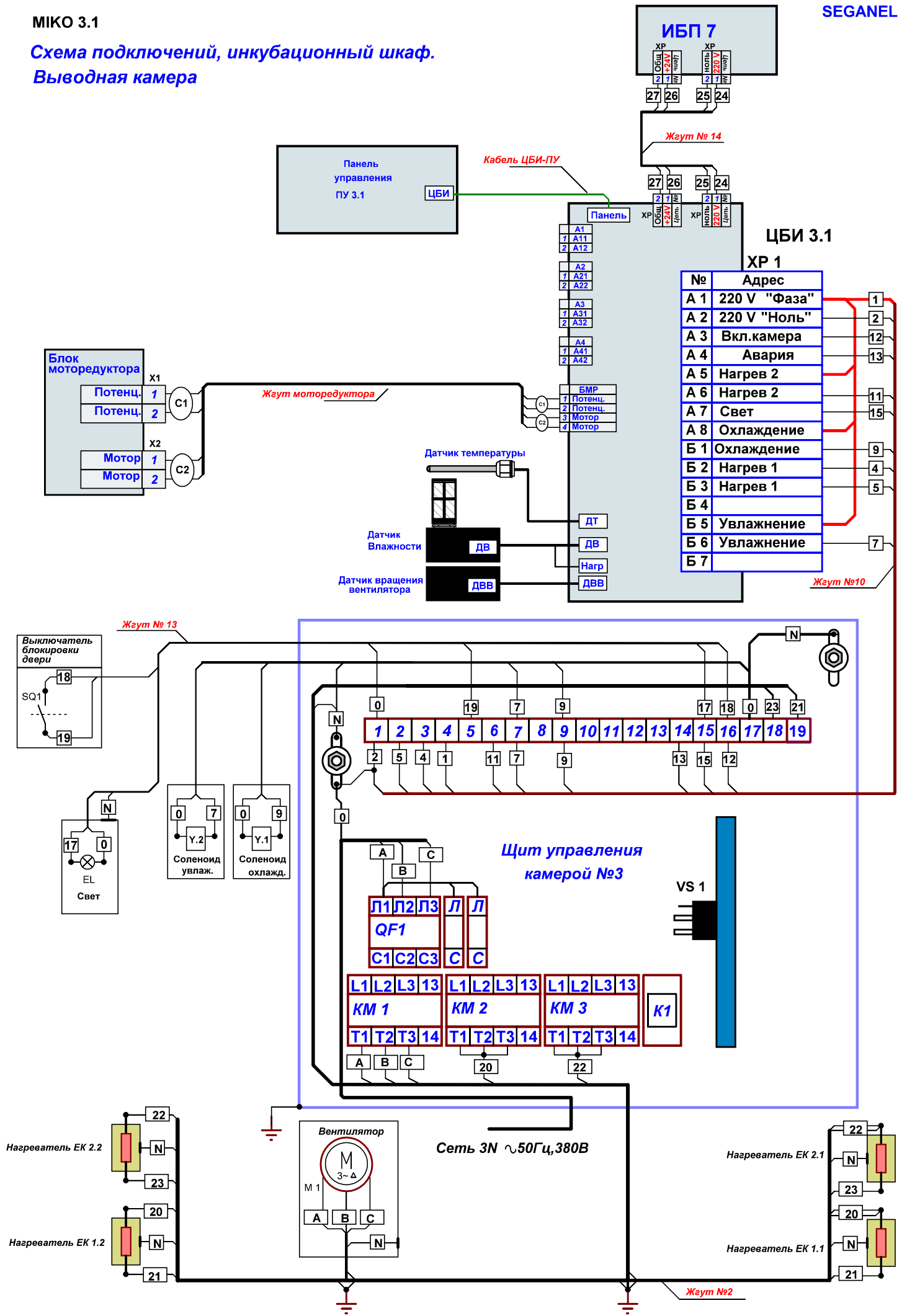

№	Адрес
A 1	220 V "Фаза"
A 2	220 V "Ноль"
A 3	Вкл. камера
A 4	Авария
A 5	Нагрев 2
A 6	Нагрев 2
A 7	Свет
A 8	Охлаждение
Б 1	Охлаждение
Б 2	Нагрев 1
Б 3	Нагрев 1
Б 4	
Б 5	Увлажнение
Б 6	Увлажнение
Б 7	

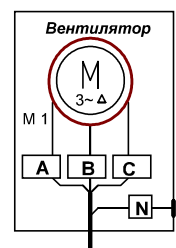
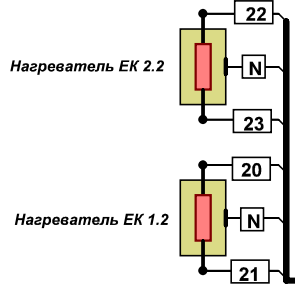
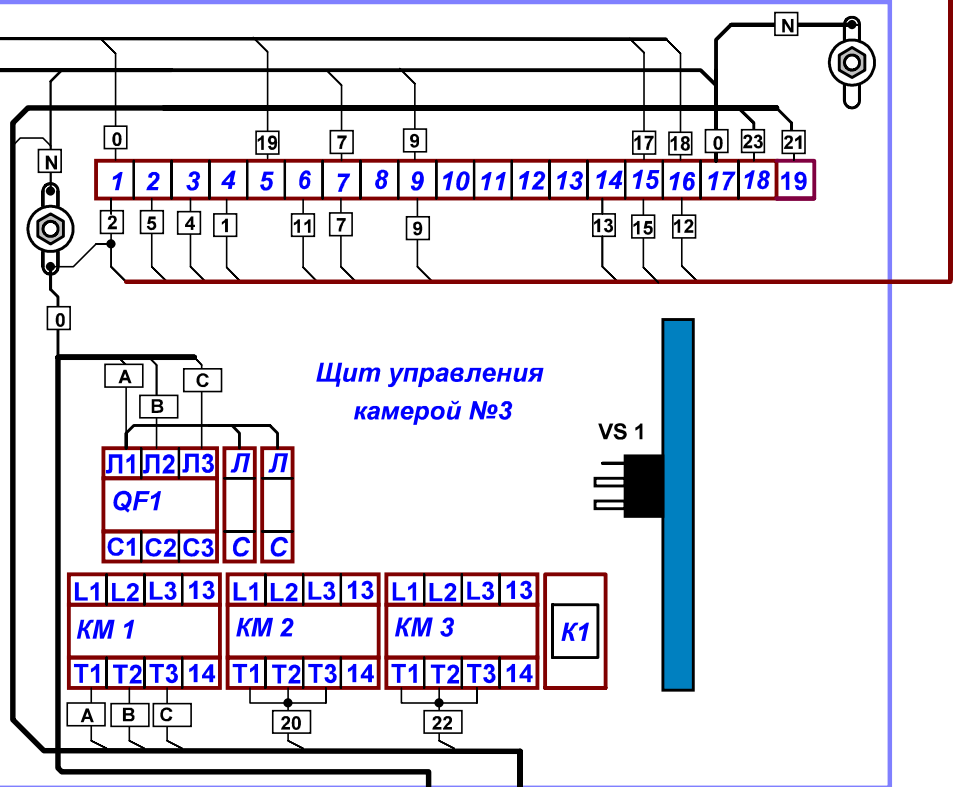
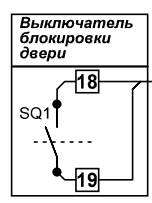
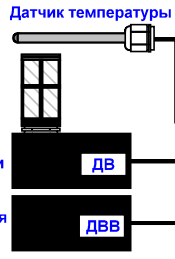
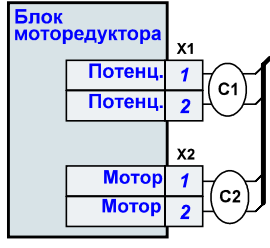
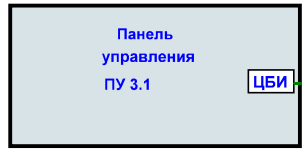

Сеть 3N ~50Гц, 380В

